

Acco® WRIGHT®

end truck accessories no. 1 flange-mounted reducer, motor, & brake

instruction and parts manual

CAUTION

Reducer is furnished with four solid plugs. After installation and prior to operation of reducer: check oil level of reducer and install breather plug as outlined in these instructions.

WARNING

This equipment should not be installed, operated or maintained by any person who has not read all the contents of these instructions. Failure to read and comply with these instructions or any one of the limitations noted herein can result in serious bodily injury and/or property damage.

Only competent engineering and fabrication personnel, familiar with standard crane design and fabrication practices, should be employed to design and fabricate cranes using this equipment because of the necessity of properly interpreting these instructions and for the purposes of determining appropriate compatible equipment and product applications. Acco disclaims any responsibility for the quality of design and workmanship employed in the design and fabrication of a crane or other system using this equipment or the sufficiency of the structure in which and to which this equipment is to be installed or the sufficiency of the crane or system to sustain any particular load that may be imposed upon it. Contact Acco Chain & Lifting Products for additional information if necessary.

There are no other warranties which extend beyond the description on the Order Acknowledgment and as it may apply to the specifications provided in this publication. THE IMPLIED WARRANTIES OF MERCHANTABILITY AND FITNESS FOR A PARTICULAR PURPOSE ARE EXCLUDED. Acco shall in no event be liable for any special, direct, indirect, incidental or consequential damages to anyone beyond the cost of replacement of the goods sold hereby.

BEATON

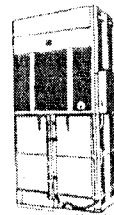
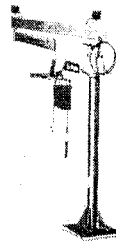
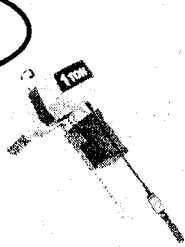

OVERHEAD EQUIPMENT
HOISTS

ERGONOMICS

HYDRAULIC
BALERS

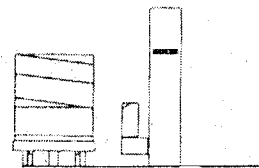
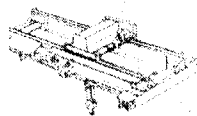
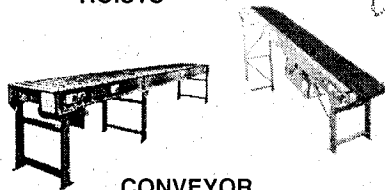

AIR CURTAINS
 BALERS/COMPACTORS
 BELOW HOOK
 BENCHES/CARTS/TOOLS
 BRIDGE CRANES
 CABINETS
 CASTERS/WHEELS
 CONTAINERS/WHEELS
 CONVEYORS
 DOCK EQUIPMENT
 ENGINEERED SYSTEMS
 FLOOR MATTING
 OVERHEAD DOORS
 DRUM HANDLING
 FLAMMABLE CABINETS
 FLOW RACK
 GANTRY CRANES
 GUARD RAIL
 HAND TRUCKS
 HIGH SPEED ROLL UP DOORS
 HOISTS
 INDUSTRIAL BATTERIES
 INDUSTRIAL VACUUMS
 INPLANT OFFICES
 INSTALLATIONS
 JIB CRANES
 LAYOUTS/DESIGNS
 LIFTERS
 LIFT TABLES
 LOCKERS
 MACHINE MOVERS
 MESSAGE TRANSFER
 MEZZANINES
 MODULAR DRAWER CABINETS
 MOBILE AISLE STORAGE
 OFFICE FURNITURE
 OVERHEAD LIFTING EQUIPMENT
 PALLETS
 PALLET TRUCKS
 PERSONNEL LIFTS
 SAFETY LADDERS
 SCALES
 SELF DUMPING HOPPERS
 SERVICE/SERVICE CONTRACTS
 STACKER CRANES
 STORAGE PRODUCTS
 STRETCH WRAP MACHINES
 SHIPPING SUPPLIES
 TABLES
 TOILET PARTITIONS
 AND MANY MORE ...

CONVEYOR

BRIDGE CRANES

WRAPPERS

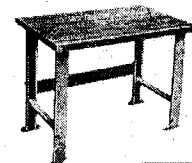
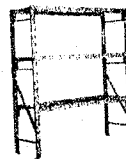
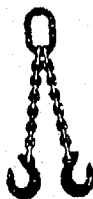

SLINGS

RACKING/SHELVES



Beaton Industrial, Inc.

6083 Trenton Road
Utica, NY 13502

Ph. 1-800-724-4052 (N.Y. Only)

Ph. 1-315-797-9346

Fax 1-315-797-9321

e-mail:

beaton@deamscape.com

Web:

www.BeatonIndustrial.com

SHOP EQUIPMENT

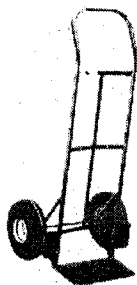

HAND TRUCKS

beaton@deamscape.com

Web:

www.BeatonIndustrial.com

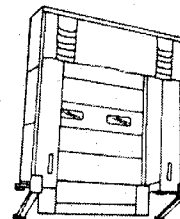

DOCKS, DOORS, SEALS

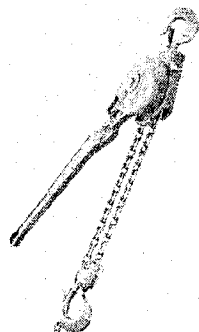

PULLERS

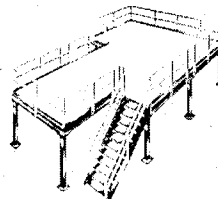

MEZZANINES

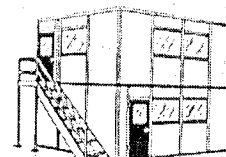

INPLANT OFFICES

HOIST AND CRANE REPAIR CENTER
 INSTALLATIONS, PARTS, SERVICE
 DESIGN/LAYOUT/ FABRICATIONS,
 APPLICATION STUDIES
 CRANE & HOIST INSPECTIONS



CASTERS

"Specializing In Materials Handling"

⚠ CAUTION

These general instructions deal with the normal installation, operation, and maintenance situations encountered with the equipment described herein. The instructions should not be interpreted to anticipate every possible contingency or to anticipate the final crane or system configuration that uses this equipment.

This manual includes instructions and parts information for a variety of crane component equipment. Therefore, all instructions and parts information may not apply to any one type or size of equipment. Disregard those portions of the instructions which do not apply.

Use only Acco authorized replacement parts in the service and maintenance of this equipment.

⚠ WARNING

Equipment described herein is not designed for and should not be used for lifting, supporting, or transporting humans.

Equipment described herein should not be used in conjunction with other equipment unless necessary and/or required safety devices applicable to the system, crane, and application are installed by the crane builder or user.

Modifications to upgrade, rerate, or otherwise alter this equipment shall be authorized only by the original equipment manufacturer or qualified professional engineer.

Equipment described herein is only for use in the design and manufacture of cranes. Additional equipment or devices may be required for the crane to comply with applicable crane design and safety standards. The crane designer, crane manufacturer, or user is responsible to furnish these additional items for compliance. Refer to ASME B30.17 for top-running single girder cranes, ASME B30.11 for underhung single girder cranes, or ASME B30.2 for top running multiple girder cranes.

Electrical equipment described herein is designed and built in compliance with ACCO's interpretation of ANSI/NFPA 70 (National Electrical Code). The crane designer, crane manufacturer or user is responsible to assure that the installation and associated wiring of these electrical components is in compliance with ANSI/NFPA 70, and all applicable Federal, State and Local Codes.

Failure to read and comply with any one of the limitations noted herein can result in serious bodily injury and/or property damage.

⚡ DANGER

HAZARDOUS VOLTAGES ARE PRESENT IN THE CONTROL BOX, OTHER ELECTRICAL COMPONENTS, AND CONNECTIONS BETWEEN THESE COMPONENTS.

Before performing ANY mechanical or electrical maintenance on the equipment, de-energize (disconnect) the main switch supplying power to the equipment; and lock and tag the main switch in the de-energized position.

Only trained and competent personnel should inspect and repair this equipment.

Wright drive kits are carefully tested and properly lubricated before shipment. Great care has been exercised in both design and manufacture to assure long, uninterrupted service. This manual contains recommendations for installation and maintenance to obtain maximum service from the drive unit.

NO. 1 FLANGE-MOUNTED DRIVE KITS

GEARBOX RATIO	MOTOR HP (EACH)	CAPACITY - TRAVEL SPEED - MAXIMUM SPAN			MOTOR AND BRAKE VOLTAGE	DRIVE KIT PRODUCT NUMBER
		SERIES 425 UNDERHUNG END TRUCKS	SERIES 430 TOP RUNNING END TRUCKS	SERIES 440 TOP RUNNING END TRUCKS		
23:1	.50	3 Ton - 45 FPM - 50 Ft. 5-10 Ton - 40 FPM - 50 Ft.	3-10 Ton - 50 FPM - 50 Ft.	3-7½ Ton - 50 FPM - 55 Ft. 10 Ton - 50 FPM - 40 Ft.	208	4050010
					230/460	4050020
					575	4050030
23:1	.50/.17	3 Ton - 45/15 FPM - 50 Ft. 5-10 Ton - 40/13 FPM - 50 Ft.	3-10 Ton - 50/17 FPM - 50 Ft.	3-7½ Ton - 50/17 FPM - 55 Ft. 10 Ton - 50/17 FPM - 40 Ft.	208	4050040
					230	4050050
					460	4050060
					575	4050070
15:1	.50	3 Ton - 75 FPM - 50 Ft. 5 Ton - 65 FPM - 50 Ft. 10 Ton - 65 FPM - 35 Ft.	3-5 Ton - 75 FPM - 50 Ft. 10 Ton - 75 FPM - 35 Ft.	3 Ton - 75 FPM - 55 Ft. 5 Ton - 75 FPM - 35 Ft.	208	4050080
					230/460	4050090
					575	4050100
	.75	10 Ton - 65 FPM - 50 Ft.	10 Ton - 75 FPM - 50 Ft.	5-7½ Ton - 75 FPM - 55 Ft. 10 Ton - 75 FPM - 40 Ft.	208	4050150
					230/460	4050160
					575	4050170
15:1	.50/.17	3 Ton - 75/25 FPM - 50 Ft. 5 Ton - 65/22 FPM - 50 Ft. 10 Ton - 65/22 FPM - 35 Ft.	3-5 Ton - 75/25 FPM - 50 Ft. 10 Ton - 75/25 FPM - 35 Ft.	3 Ton - 75/25 FPM - 55 Ft. 5 Ton - 75/25 FPM - 35 Ft.	208	4050110
					230	4050120
					460	4050130
					575	4050140
	.75/.25	10 Ton - 65/22 FPM - 50 Ft.	10 Ton - 75/25 FPM - 50 Ft.	5-7½ Ton - 75/25 FPM - 55 Ft. 10 Ton - 75/25 FPM - 40 Ft.	208	4050180
					230	4050190
					460	4050200
					575	4050210
10:1	.50	3 Ton - 110 FPM - 50 Ft. 5 Ton - 95 FPM - 50 Ft.	3-5 Ton - 110 FPM - 50 Ft.	3 Ton - 110 FPM - 35 Ft.	208	4050220
					230/460	4050230
					575	4050240
	.75	10 Ton - 95 FPM - 35 Ft.	10 Ton - 110 FPM - 35 Ft.	3 Ton - 110 FPM - 55 Ft. 5 Ton - 110 FPM - 35 Ft.	208	4050290
					230/460	4050300
					575	4050310
	1.00	10 Ton - 95 FPM - 50 Ft.	10 Ton - 110 FPM - 50 Ft.	5-7½ Ton - 110 FPM - 55 Ft. 10 Ton - 110 FPM - 40 Ft.	208	4050360
					230/460	4050370
					575	4050380
10:1	.50/.17	3 Ton - 110/37 FPM - 50 Ft. 5 Ton - 95/32 FPM - 50 Ft.	3-5 Ton - 110/37 FPM - 50 Ft.	3 Ton - 110/37 FPM - 35 Ft.	208	4050250
					230	4050260
					460	4050270
					575	4050280
	.75/.25	10 Ton - 95/32 FPM - 35 Ft.	10 Ton - 110/37 FPM - 35 Ft.	3 Ton - 110/37 FPM - 55 Ft. 5 Ton - 110/37 FPM - 35 Ft.	208	4050320
					230	4050330
					460	4050340
					575	4050350
	1.00/.33	10 Ton - 95/32 FPM - 50 Ft.	10 Ton - 110/37 FPM - 50 Ft.	5-7½ Ton - 110/37 FPM - 55 Ft. 10 Ton - 110/37 FPM - 40 Ft.	208	4050390
					230	4050400
					460	4050410
					575	4050420

Each Drive Kit includes two assembled and prewired Motors, Brakes, and Reducers. Each kit also contains Mounting Hardware, Breather Plugs, and an Instruction and Parts Manual.

BEFORE INSTALLATION

1. Check for damage during shipment. Place a claim with carrier if any is discovered. **DO NOT** install a damaged drive unit.
2. Refer to the MOUNTING POSITIONS figure below. Remove the solid shipping plug and replace it with the breather plug that accompanied the drive unit. The hole in the breather plug should be installed to face upward.
3. Check oil level. Oil should be even with the oil level hole. Add oil if necessary. For type of oil see LUBRICATION section.
4. Check power supply. Motors with 230/460 volt nameplates can be reconnected in the field for a 230 or 460 volt power supply. Motor brakes coils marked 230/460 VAC are also reconnectable for 230 and 460 volts (see MAINTENANCE section for connections).

MOUNTING POSITIONS

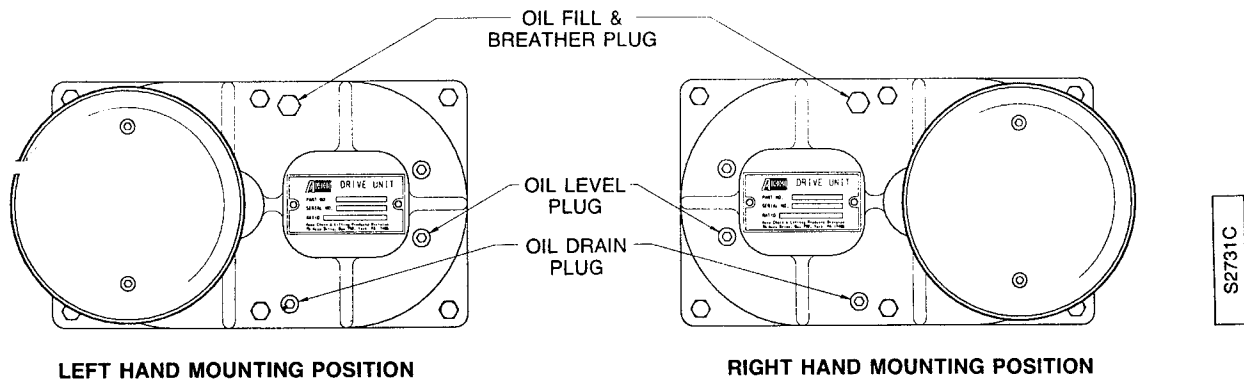

OPERATION

Operation of the drive unit is in fact operation of the equipment for which it supplies the drive. To realize the utmost in performance and length of service we recommend:

1. **NEVER** overload the unit.
2. **NEVER** jog (i.e. operate in a jerking manner).

LUBRICATION

GEAR HOUSING

For normal service, replace gear housing oil after 300 operational hours or 6 months, whichever comes first. Replace oil more frequently for heavy duty. Select lubricant from the table on the right. Fill until oil is level with the oil level hole. (Refer to figure above.)

AMBIENT TEMPERATURE	LUBRICANT
50° to 120°F (10° to 49°C)	AGMA No. 6
15° to 60°F (-9° to 16°C)	AGMA No. 4
Under 15°F (-9°C)	Contact Factory

EXPOSED PINION AND GEARS

Drive unit pinion and mating gears should be kept well coated with NGLI No. 2 grease.

MAINTENANCE

MOTOR BRAKE

⚠ DANGER

DISCONNECT POWER AND LOCKOUT DISCONNECTING MEANS BEFORE REMOVING COVER OR SERVICING THIS EQUIPMENT. SERVICE SHOULD BE PERFORMED ONLY BY A QUALIFIED ELECTRICIAN.

Check braking mechanism daily for ability to stop equipment. If efficiency of brake indicates a need for adjustment, proceed with the following steps. Refer to the figure below to identify brake parts.

1. Remove brake cover. Clean out brake dust from brake cover and all brake parts with an air line or a brush.
2. Measure the thickness of the brake lining disc. Replace if worn to 3/32 inch, or if cracked, broken or has come in contact with oil or other substances.
3. Check the air gap between the magnet unit and pressure unit. As the brake disc wears, the original air gap setting of .020 inches increases. The maximum allowable air gap is .045 inches.

To adjust the air gap, loosen the adjusting nuts to allow the magnet unit to move toward the pressure unit. Using a feeler gage, set the air gap to .020 inches. Tighten the adjusting nuts and check the air gap at several points to be sure it is set uniformly.

4. As the brake disc wears, the spring length increases. Select the spring length, based on the motor HP, from the chart on the right. Adjust both spring lengths accordingly with the spring tension nuts.

MOTOR HP 1800 RPM	BRAKE TORQUE (LB FT)	SPRING LENGTH (INCHES)
1/2	3/4	1-5/8
3/4	1-1/8	1-9/16
1	1-1/2	1-1/2

If stopping performance is unsatisfactory, increase spring length for less torque or decrease spring length for more torque.

5. When reinstalling the brake cover, the ends of the rubber gasket should face downward. This will help prevent water or foreign substances from getting inside the brake cover.

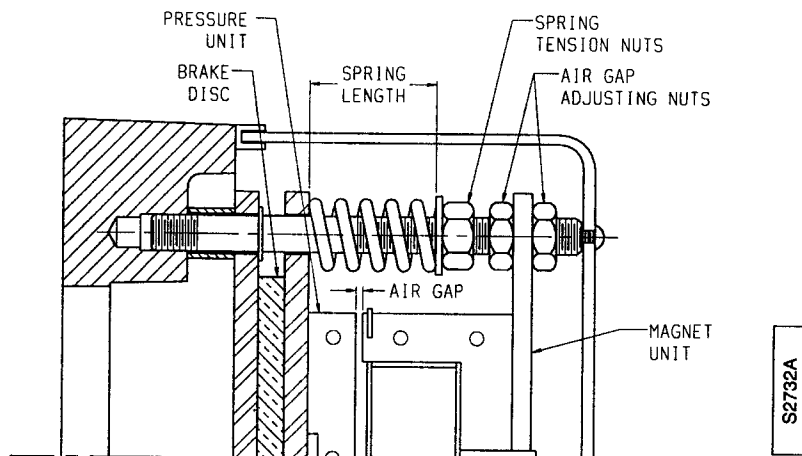

BRAKE COIL CONNECTIONS

Brake coil part number 39783-3 labeled 230/460 VAC may be connected for 230 or 460 volts. See the diagram on the right for connections.

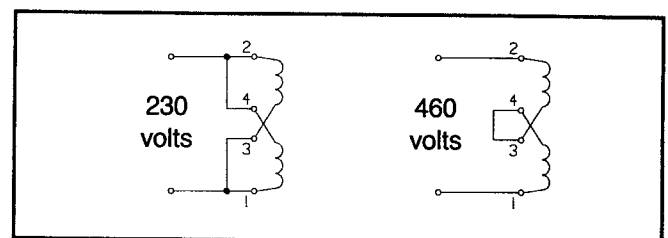

NO. 1 FLANGE-MOUNTED REDUCER PARTS

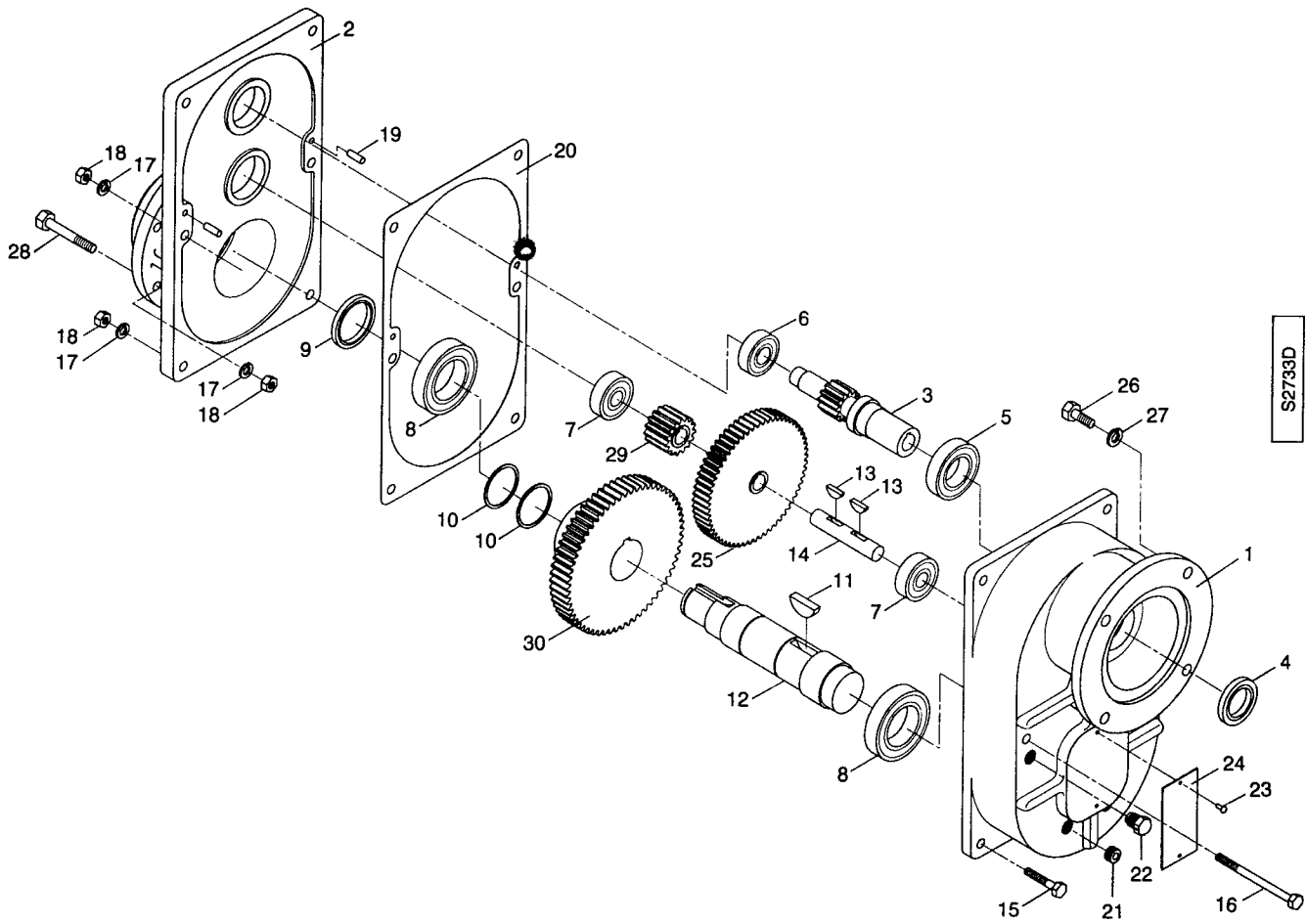

NO. 1 FLANGE-MOUNTED REDUCER PARTS

ITEM NO.	PART NUMBER	DESCRIPTION	QTY/ ASSY
1	69407	Input Reducer Housing	1
2	69409	Output Reducer Housing	1
3	69415	Motor Pinion Shaft	1
4▲	PA6662	Oil Seal	1
5	PA6655	Bearing	1
6	PA2464	Bearing	1
7	PA1129	Bearing	2
8	PA1569	Bearing	2
9▲	PA1993	Oil Seal	1
10	PA7349	Retaining Ring	2
11	PA1416	Woodruff Key	1
12	69417	Output Shaft	1
13	PA1175	Woodruff Key	2
14	69416	Intermediate Shaft	1
15	35-5-24	Bolt 5/16-18 x 1-1/2	4
16	35-5-60	Bolt 5/16-18 x 3-3/4	2
17	17-5C	Lockwasher 5/16	10

ITEM NO.	PART NUMBER	DESCRIPTION	QTY/ ASSY
18	22-5C	Hex Nut 5/16-18	10
19	PA5439	Dowel Pin	2
20▲	69405	Gasket	1
21	PA786	Hex Socket Pipe Plug	3
22	PA7350	Breather Plug	1
23	PA897	Drive Pin	2
24	69106	Serial Plate	1
25	69414	Intermediate Gear	1
26	35-6-16	Motor Mounting Bolt 3/8-16 x 1	4
27	17-6C	Lockwasher 3/8	4
28	35-5-24	Reducer Mtg. Bolt 5/16-18 x 1-1/2	4
	35-5-36	Reducer Mtg. Bolt 5/16-18 x 2-1/4	

CRANE SPEED	40-50 FPM	65-75 FPM	95-110 FPM
GEAR BOX RATIO	23:1	15:1	10:1
ITEM 29 PART NO.	69411	69412	69413
ITEM 30 PART NO.	B4073	B4074	B4075

▲ Recommended Spare Parts

MOTOR BRAKE PARTS

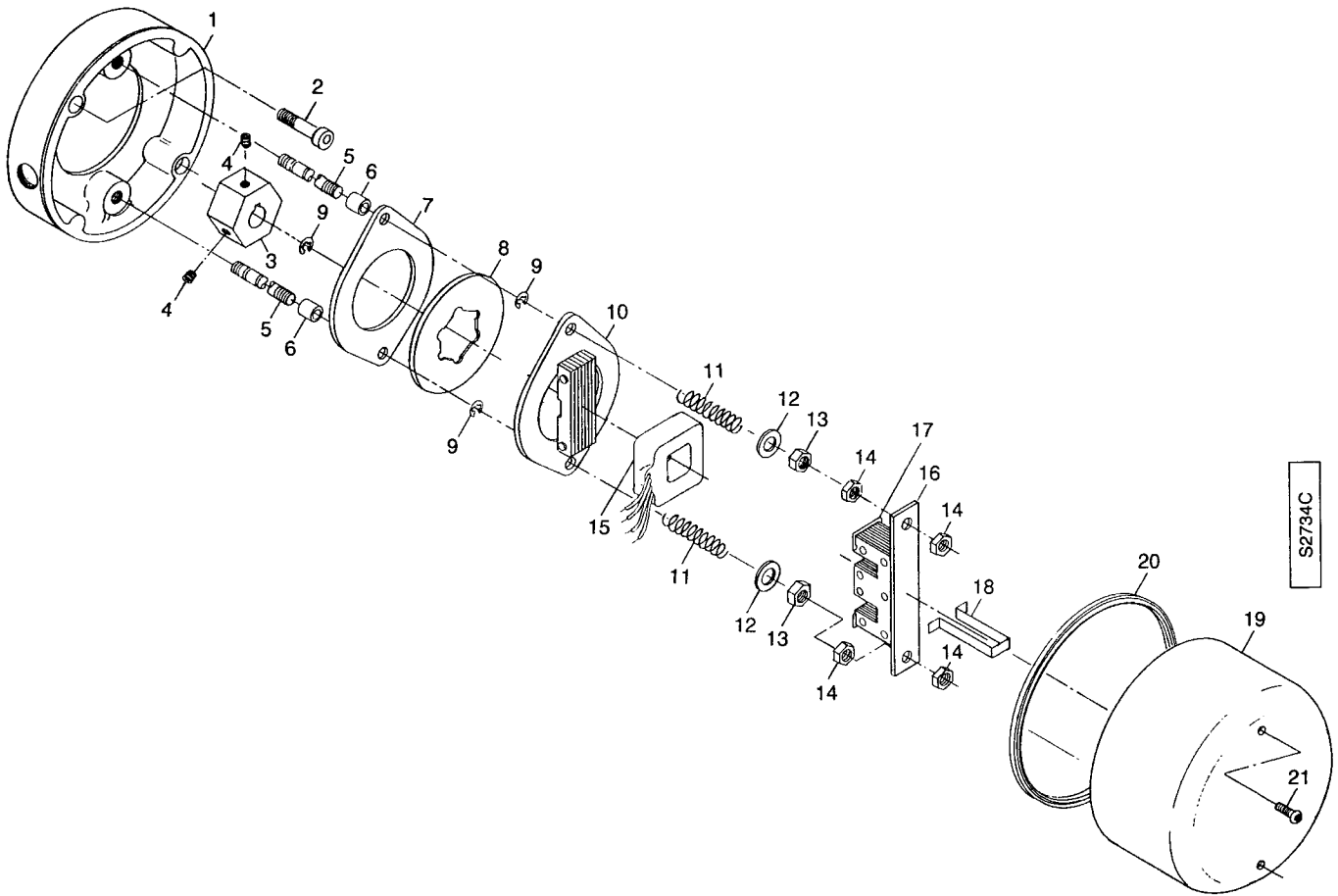

MOTOR BRAKE PARTS

ITEM NO.	PART NUMBER	DESCRIPTION	QTY/ ASSY
1	65653	Adapter	1
2	1-6-24	Bolt, 3/8-16 x 1-1/2 lg	2
3	65654	Hub	1
4	12-4-6	Set Screw	2
5	65655	Stud	2
6	61459	Spacer	2
7	39794	Brake Plate	1
8▲	39649	Brake Lining	1
9	PA5623	Retaining Ring	2
10	39781	Pressure Unit	1
11	PA5823	Spring	2
12	15-6-1	Flat Washer	2

ITEM NO.	PART NUMBER	DESCRIPTION	QTY/ ASSY
13	PA2377	Locknut	2
14	24-6	Jam Nut, 3/8	4
15▲		Coil	1
	39783-2	575 VAC	
	39783-3	230/460 VAC	
	39783-6	208 VAC	
16	39780	Magnet Unit	1
17	39784	Shading Coil (a)	2
18	39877	Coil Strap	1
19	69161	Brake Cover	1
20	PA7110	Gasket	1.77 ft
21▲	PA7323	Screw, LOC-WEL, #10-24 (b)	2

▲ Recommended Spare Parts

- (a) Shading Coil is furnished with Magnet Unit, but also available as a spare.
- (b) Screw with self-locking feature must be utilized. Substitutes are not permissible.

REPLACEMENT MOTORS

PART NUMBER	MOTOR DESCRIPTION			
	VOLTS	HP	RPM	
65818-04	208	.50	1800	
65818-05	230/460			
65818-06	575			
65818-07	208	.75		
65818-08	230/460			
65818-09	575			
65818-10	208	1.00		
65818-11	230/460			
65818-12	575			
65819-01	208	.50/.17		1800/600
65819-02	230			
65819-03	460			
65819-04	575			
65819-05	208	.75/.25		
65819-06	230			
65819-07	460			
65819-08	575			
65819-09	208	1.00/.33		
65819-10	230			
65819-11	460			
65819-12	575			

OTHER DRIVE ITEMS AVAILABLE

PART NO.	DESCRIPTION
51291	15 Tooth Drive Pinon
PA3269	Pinion Retaining Ring
68290	Pinion Key

GENERAL CONDITIONS OF WARRANTY

WARRANTIES: The Seller warrants to the original using Buyer thereof that the goods sold under this Agreement are free from defects in workmanship and materials for a period of one year from the date of shipment to the original using Buyer. No other express warranties are given and no affirmation of Seller or Seller's agents, by word or action, shall constitute a warranty. No warranty is made for components and accessories made by others when such items are warranted by their respective manufacturers.

Installation or operation of the equipment in any manner other than as recommended by Seller, shall void the warranty. Any variations in details between the goods furnished herein and those covered in Buyer's specifications are due to standards of manufacture not to be construed as exceptions to the specifications.

DISCLAIMER OF IMPLIED WARRANTIES:

- (a) SELLER MAKES NO WARRANTY OF MERCHANTABILITY IN RESPECT TO THE GOODS SOLD UNDER THIS AGREEMENT.
- (b) This sale is made WITHOUT ANY WARRANTY BY SELLER THAT THE GOODS ARE SUITABLE FOR ANY PARTICULAR PURPOSE.
- (c) Buyer hereby waives all other warranties, guarantees, obligations, liabilities, rights and remedies arising by law or otherwise including any obligation or liability of the Seller arising from tort, and Buyer shall indemnify Seller from any liability, loss, damage, or claim arising from Buyer's tortious use of the goods sold hereby.

REMEDIES:

- (a) Under no conditions shall any goods be returned to Seller without its prior written consent.
- (b) The Buyer's sole and exclusive remedy for breach of any warranty is limited to Seller furnishing at its expense duplicate or repaired parts f.o.b. Seller's plant with installation at Buyer's expense if discovery of a claimed defect occurs during the allowable warranty period, and if Seller's inspection determines a defect exists.
- (c) The quantity of material shown by invoice shall in all cases govern settlement for shortages, unless notice of shortage, appropriately documented, is given to the carrier and the Seller upon delivery by the carrier.
- (d) Claims for errors, deficiencies or imperfections shall be deemed waived by the Buyer unless Seller is notified in writing of the basis of such claims within 10 days after discovery of claimed defect and such discovery occurs within the warranted period.
- (e) Neither Buyer nor user shall be entitled under this Agreement to recover from Seller any incidental or consequential damages of any nature including but not limited to the cost of any labor expended by others in connection with the goods sold hereby by reason of any alleged nonconformity or breach of warranty on the part of the Seller nor costs of material or account thereof, nor any lost profits whether determinable or speculative.



Acco Chain & Lifting Products Division

76 Acco Drive, Box 792, York, PA 17405
717 741-4863 Fax 717 741-8572

© FKI Industries Inc. 1993
Printed in U.S.A.